

acristalia

where you want to be

CATALOGUE

GLASS CURTAINS / SLIDING
CURTAIN / SLIDING ROOF / GLASS
RAILINGS / WINDBREAKS

GIBCA



جی بیکا

GIBCA FURNITURE INDUSTRY CO. LTD. (LLC)



acristalia



Index

Prologue	4
Company	9
Create your own space	11
GLASS CURTAINS	
Standard Series	12
Basic Pro Series	18
Star Series	24
SLIDING CURTAIN	
Tandem Series	28
SLIDING ROOF	
Sliding Series	32
GLASS RAILINGS	
Railing Series	38
WINDBREAKS	
FLK Series	44
Technical details	49
Projects	54

Prologue

Major constructions and projects, automation investments, IT tools improvements, export development... All these actions demonstrate the capacity of our structure to host significant international projects. Our multidisciplinary team makes it possible as it is composed of different generations learning from each other day after day. This association of experience and audacity is at the heart of each department and comes through our conceptions and projects.

Brand and product

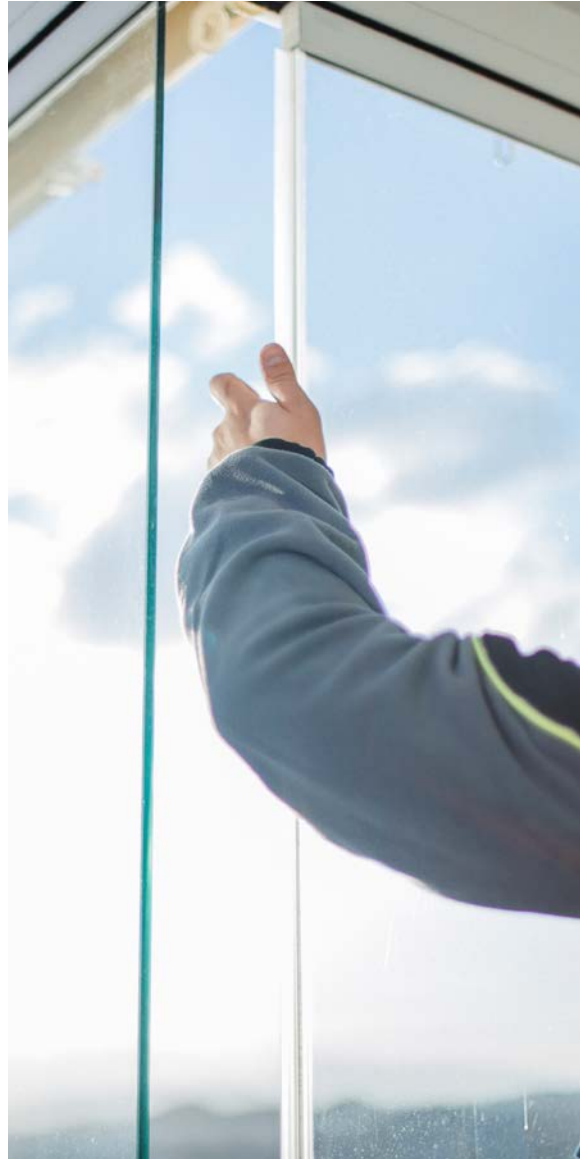

Our product is included in the enclosures sector. Nevertheless, we are aware that it is not obvious for everybody what “the enclosures” do represent. Moreover, this word says the opposite of what we advocate: the opening to the outside. Even though we can’t change it as it is the name of the sector to which our company belongs, we can turn it into something coherent.

acristalia
efficient glass enclosures



**Acristalia
products make
a difference and
it is a definite
logistic asset.**

From start to finish

We manufacture custom-made products from scratch to suit customer requirements.



Aluminium structures, glass transformation, enclosure systems, they are all manufactured according to the needs of our clients. Our R&D engineers have cutting-edge IT and prototyping tools for the production of glass enclosures, just like our workers handling the glass in our factory, who can carry out their work thanks to the highest technology of the sector.



acristalia
where you want to be

Company



The Acristalia founding team is composed of three people, brought together by the same passion for the glass. In 2007, two brothers and a friend of them gathered around a common vision: to get to install glass curtains beyond their imagination. And they came a long way and got very far, reaching installations in 20 countries in 2017. These three friends, with three complementary

executive profiles, have updated the concept of glazing from its bases and decided to move forward the same horizon. Acristalia was born in a small aluminium carpentry and has met the challenge to turn into a fast-growing and international-oriented company constantly evolving thanks to its efforts, tenacity and dedication.



**Create your
own space.**

GLASS CURTAINS

Standard Series
Basic Pro Series
Star Series

SLIDING CURTAIN

Tandem Series

SLIDING ROOF

Sliding Series

GLASS RAILINGS

Railing Series

WINDBREAKS

FLK Series

Standard series

The Glass Curtain Standard Series will allow you to take the most advantage of your outdoor spaces: large views, comfort and sensation of having more space. It is the most versatile and panoramic option on the market.



acristalia

Link to product



Endless possibilities

The configuration options of the Glass Curtain Standard Series are almost unlimited: enclosures at different heights, with or without corners or with embedded bottom rail. By associating measures, types of glass, finishes and colours, we can suit every project requirements.



Up to 3 metres high, panels up to 80 cm wide, glasses from 6 to 12 mm thickness and embedded bottom profile to make easier the accessibility.

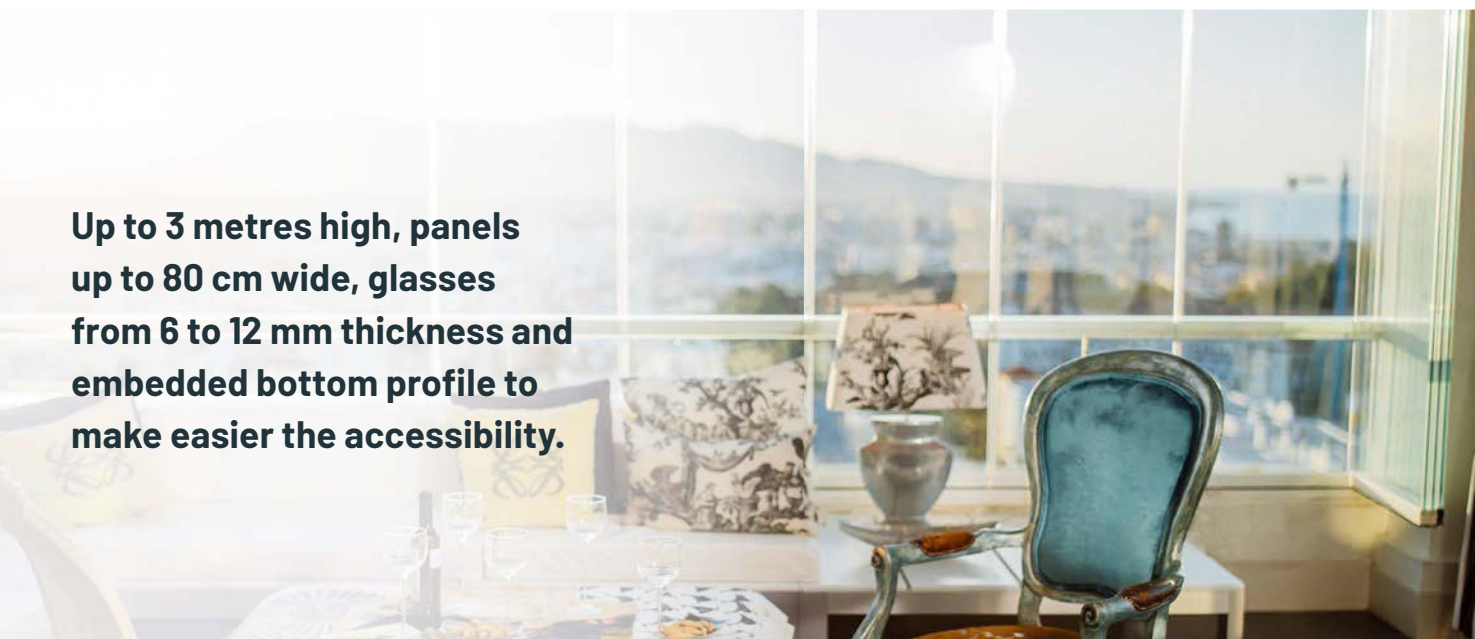



The Standard Series offers more space and comfort. It is an aesthetic and functional system, combining reliability and robustness.





Basic Pro

series

The Basic Pro Series meets the needs of the most demanding customers without neglecting the quality. With a minimalist design and by minimizing the visible aluminium, this system offers large views, more comfort and functionality.



Link to product



Design and functionality

This series incorporates an armless upper wheel outlet system, designed for making easier the addition of accessories such as tissue curtains or awnings. Moreover, its finish is 100% aesthetic and you will have the choice between all the RAL colours, anodized finish and wood imitation.



Up to 2 meters high, panels of 70 cm wide, glasses from 6 to 10 mm thickness and compatible with the Railing Series. Thanks to the compensation profile, the difference of levels on existing structures is not a problem.





Our Basic Pro Series are probably the most versatile glass curtains on the market.





Star series

The Star Series is a glass enclosure system without bottom guide, working with sliding individual panels connected between each other, ensuring reliability and simplicity when handling them.



Link to product



Clear and easy handling

Once the glass curtains are open, they leave the doorway clear, without obstacles obstructing free passage. It amplifies the feeling of space and comfort.



Up to 4 metres high, panels up to 1140 mm wide, without bottom guide and all types of glass: tempered glass, laminated, solar control and all composition reaching 10 or 12 mm thickness. In addition, the system includes a "storage zone" at the end of the structure which allows stacking the panels efficiently.



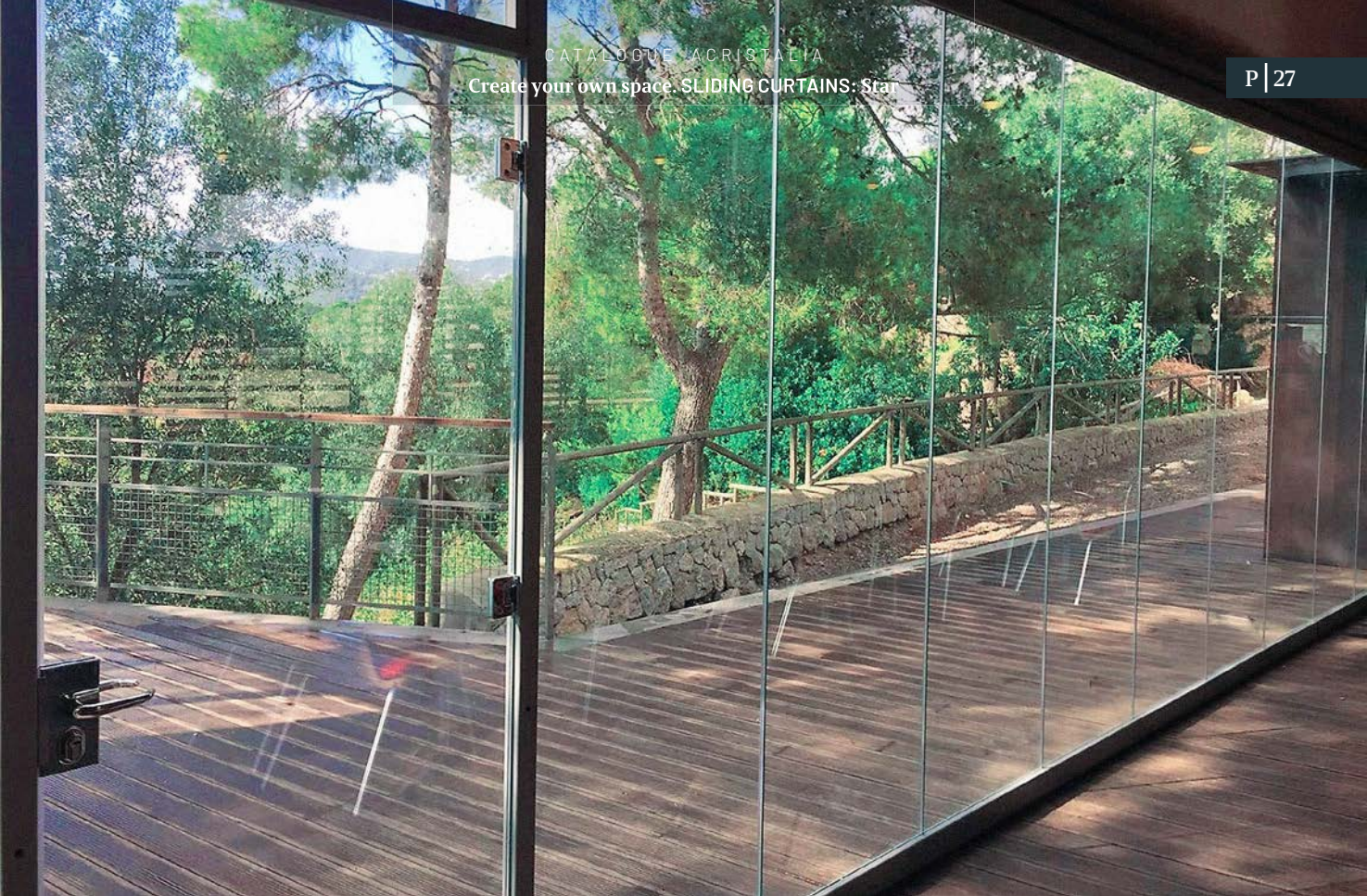

**The Star Series
is a modern glass
curtains that can be
up to 4 metres high.**

Tandem series

Our Sliding Curtain system Tandem Series with horizontal sliding panels does not have vertical profiles, providing a panoramic view. The height can be regulated, there are many options for additional safety of the system and it is optimized to evacuate water away easily.



Link to product



A new enclosure option

The sliding system has been developed by Acristalia in an AISI 316 stainless steel raceway, avoiding the deterioration caused by a daily use and offering a better durability. The opening and closing of the whole system is done by moving only the first panel.



Up to 3.5 metres high, the system has two stainless steel tandem bearings that can handle panels up to 200 kg. The Tandem Series can include up to 10 panels per system and all types of glass: tempered, laminated, solar control and all composition reaching 10 or 12 mm thickness.



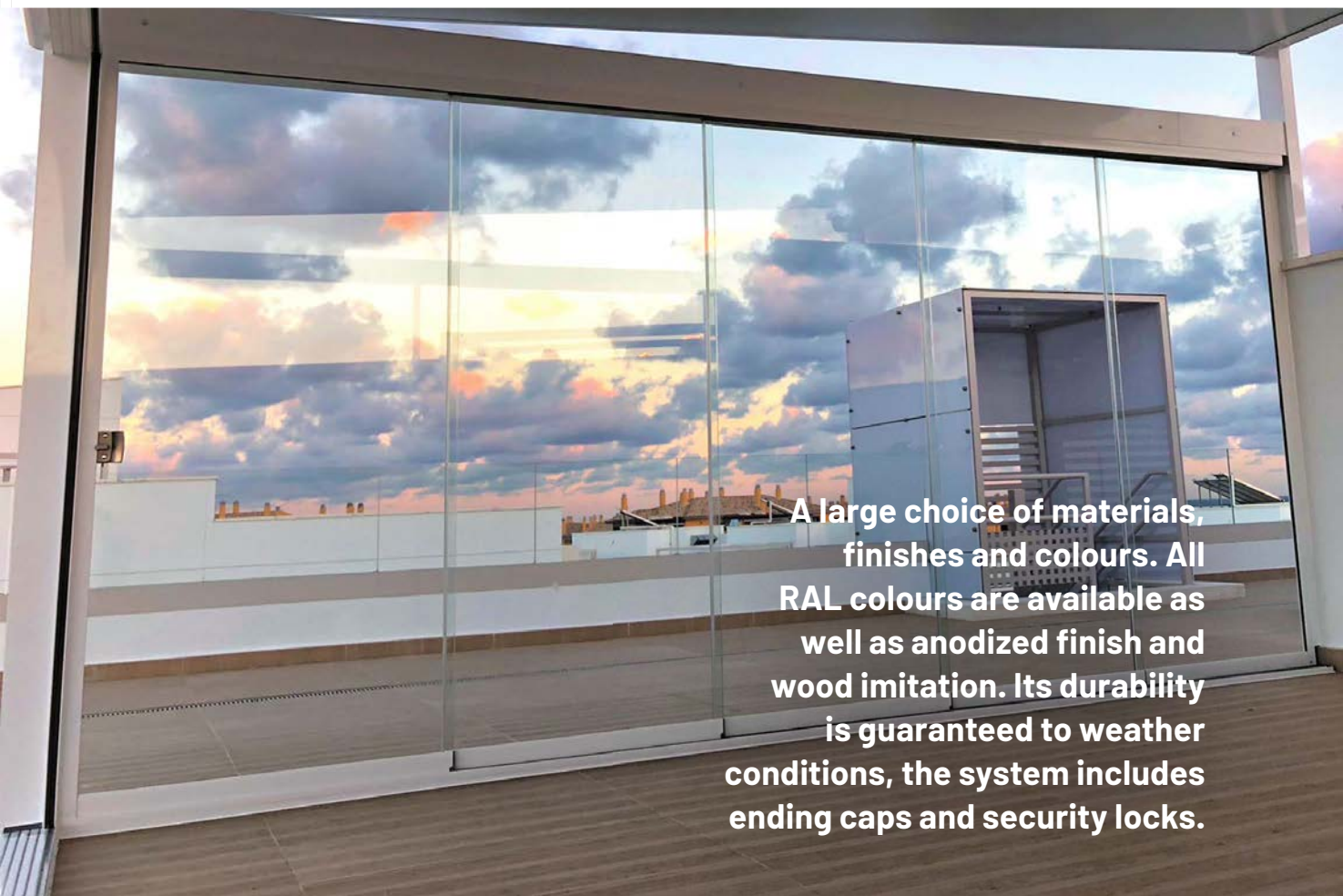

A large choice of materials, finishes and colours. All RAL colours are available as well as anodized finish and wood imitation. Its durability is guaranteed to weather conditions, the system includes ending caps and security locks.

Sliding series

We manufacture custom-made structures according to the requirements of each project. The system can be adapted to many shapes, with maximum depth of 7 metres and no limitation regarding the width. The roof makes possible the opening up to 80% of its total surface, providing a 360° view.

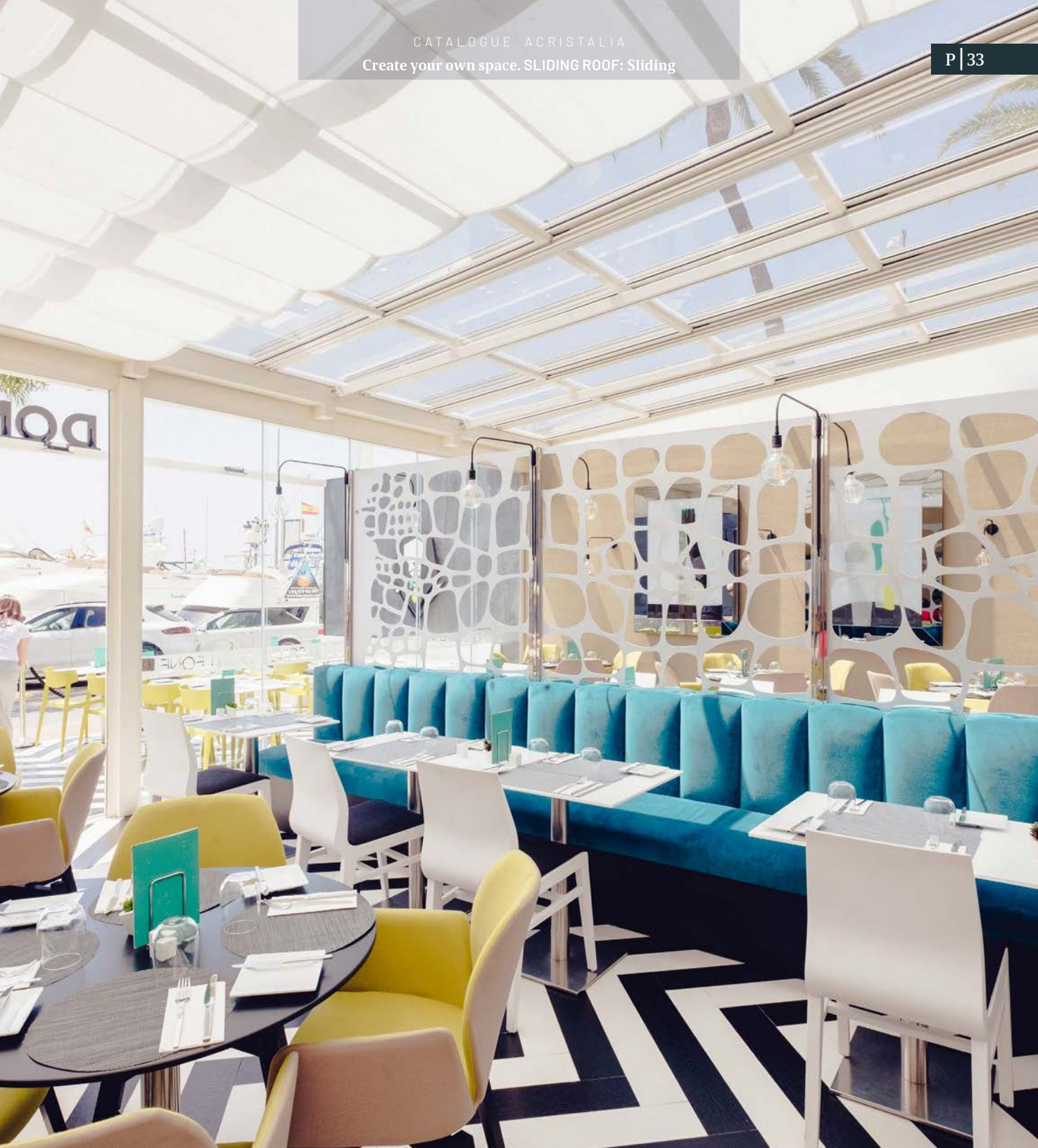

For every taste

All RAL colours are available for the aluminium profiles as well as anodized finish and wood imitation. Several options can be added, such as LED lighting and awnings, that can be directly integrated to the structure and are available in several colours. The motor is discrete and hidden, integrated in the system.



Acristalia Sliding Roof matches with every client's expectations and has been submitted to tests and essays whose results and conditions are available on our website www.acristalia.com



A modern rooftop terrace featuring a sliding glass roof system. The terrace is furnished with a light-colored sectional sofa on a wooden deck. The background shows a cityscape and mountains under a clear sky. The sliding roof is made of glass panels supported by a metal frame, and the interior wall is a warm, textured orange color. The floor is made of dark wood planks. The overall atmosphere is bright and airy, with natural light streaming through the glass roof.

To secure and facilitate the work of professional installers, our R&D department has been working hard to obtain a system that allows the installation from the inside, avoiding the potential risks during the assembly.

Quality finishes

Within a sector as competitive as ours, we have to offer something different. Acristalia has succeeded in creating a Sliding Roof suitable for the particular and professional sector.

1. Integrated awnings.
2. Installation from the inside.
3. Motorized panels motion.
4. Wind and rain sensors.
5. Innovating design for domestic or professional use.
6. Compatible with glass curtains.



Solar protection: awnings and pergola fabrics.

Pergola fabrics

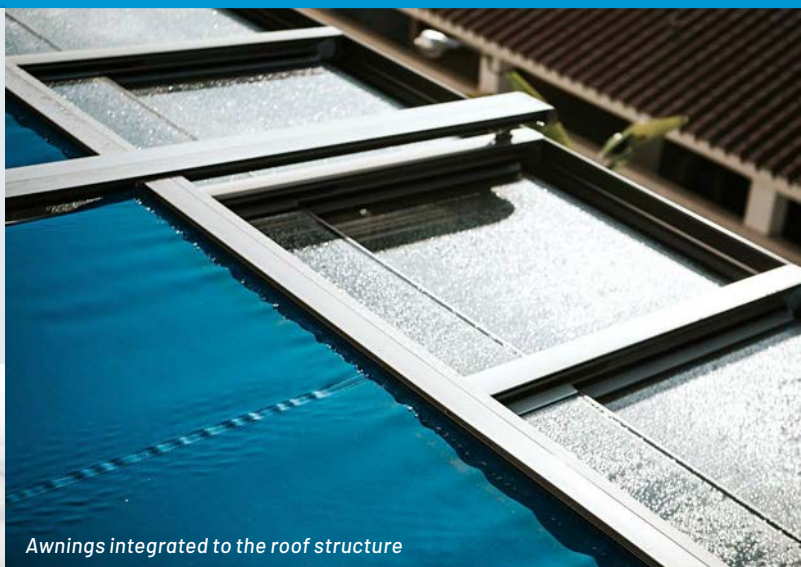

Awnings integrated to the roof structure

As part of its commitment to comfort and feeling of well-being of its customers, Acristalia offers several solutions of solar protection, compatibles and integrated to the structure of the Sliding Roof: awnings, vertical or horizontal pergola fabrics.



somfy®

Number one in motorization

The Sliding Roof with motorized option integrates last generation motors provided by the brand Somfy and able to move rows of panels without any problem. The motion is operated thanks to a small remote control.

Link to product



Railing series



Different options of glass thickness: 6+6, 8+8, 10+10 and 12+12, laminated or tempered-laminated, totally compatibles with the glass curtains and the sliding roof. In addition, there is the possibility to choose between more than 200 colours of the RAL chart.



Link to product



Panoramic view

Our glass railings are characterized by their design and functional aspect. With an elegant and minimalist design, this system allows to close spaces with absolute transparency and safety.



Our glass railings are 100% compatible with Basic Pro Glass Curtains, in terms of structure and design, creating an elegant panoramic combination, both functional and reliable.



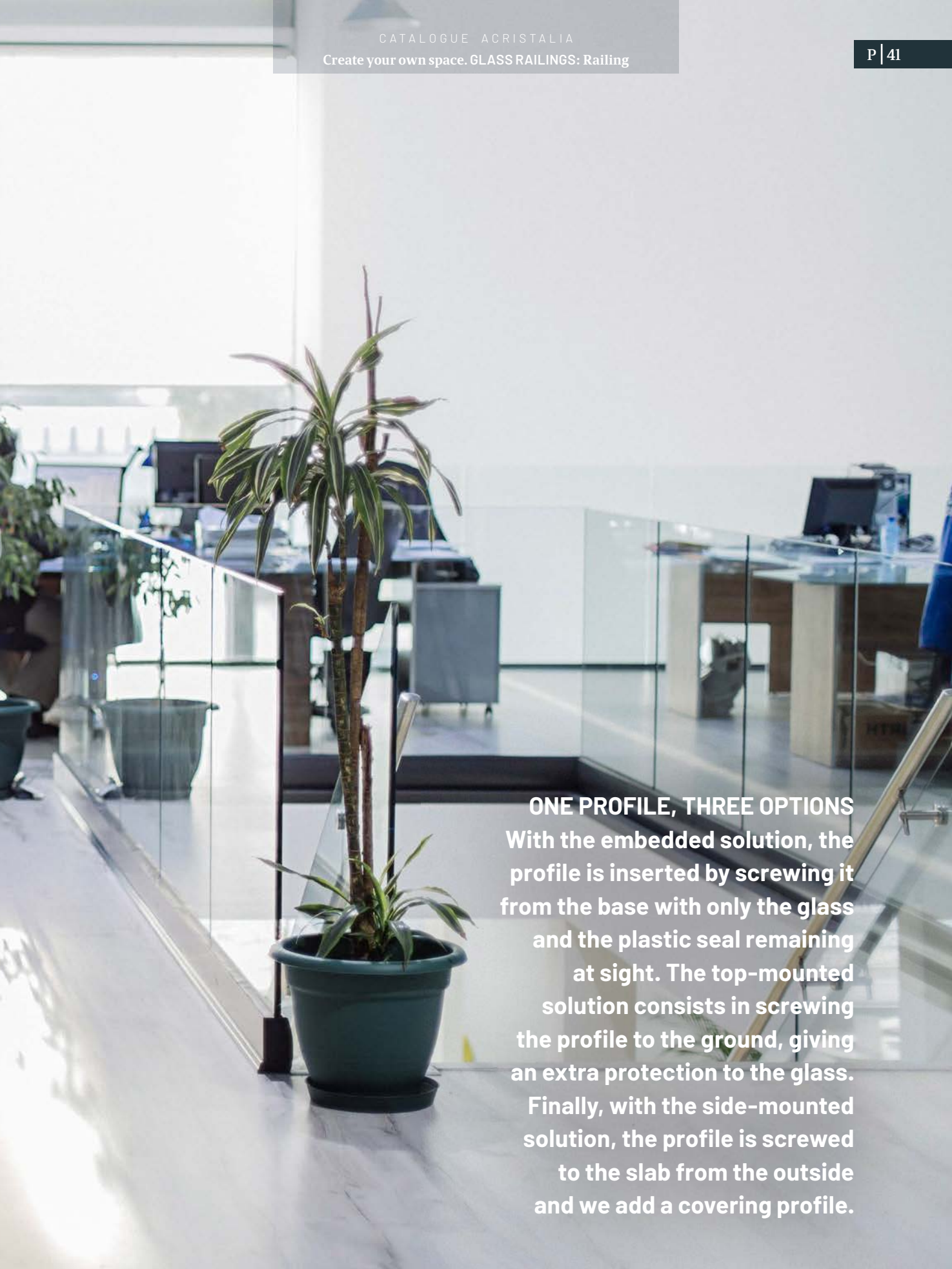

ONE PROFILE, THREE OPTIONS
With the embedded solution, the profile is inserted by screwing it from the base with only the glass and the plastic seal remaining at sight. The top-mounted solution consists in screwing the profile to the ground, giving an extra protection to the glass. Finally, with the side-mounted solution, the profile is screwed to the slab from the outside and we add a covering profile.



Jacuzzi

PATOLOGIAO BIT
EMBARAZAD
NIÑO
PATOLOGIAS CARDI
RIZTO DE USU
ESTA
E SE HI COND
ESTA TOMADO MEDICAM
PRODU
NIÑO DE FISI
BAO SUPERVISOR
PREN
CHILD
DIABETES OR
REST D
IF YOU HAV
IF YOU'RE TAKING MED
ANY MEDICA
CHILDREN SHOULD BE
UNDER AN ADULT
SUPERVISION AT ALL
TIMES

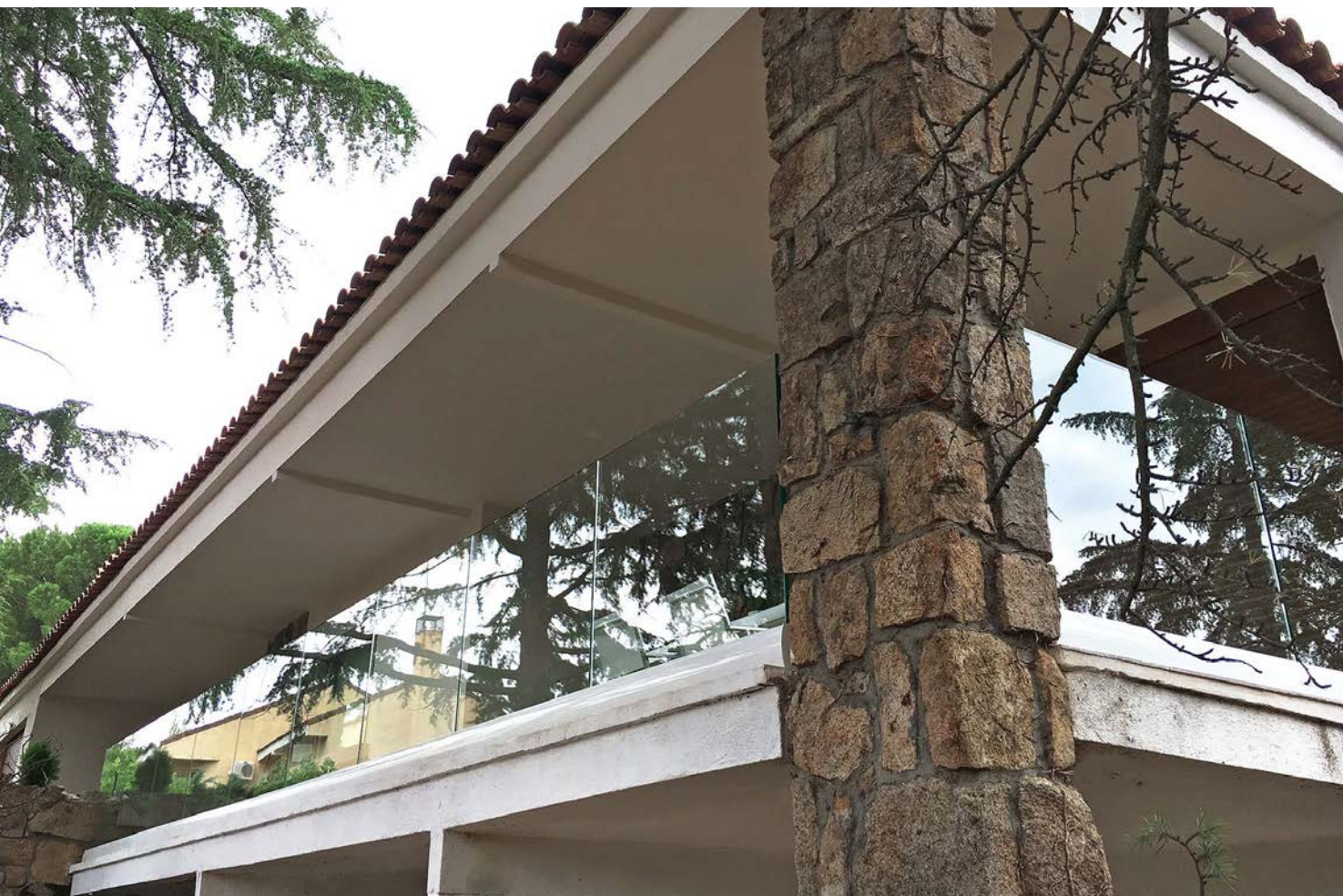

FLK series



The FLK Windbreaks are extraordinarily adapted and adaptable. It is magnificent solution for hotels and restaurants. With our exclusive semi-automatic system.



Link to product



Adapted to public spaces

Some municipalities prohibit ground fixations. With the windbreaks from FLK Series, this problem is avoided thanks to its multiple supports such as wheels or growers.



The FLK Windbreaks are the best solution for those looking for a quick installation, at an economical price and without renovation work. In addition, it allows to change the atmosphere maintaining the views and the luminosity.



acristalia

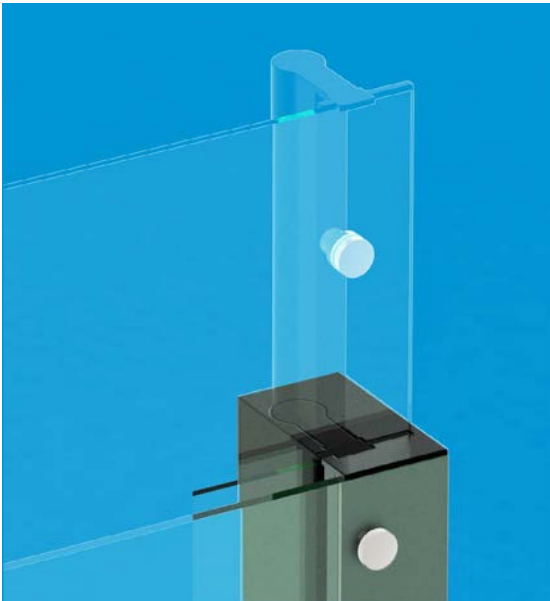

It is the only system with automatic opening. By pressing down the movable part, it rises instantly and reaches its extended height to enclose a terrace for example, offering a feeling of space, comfort and security.



OPTIONS



It is the only system with automatic opening. By pressing down the movable part, it rises instantly and reaches its extended height to enclose a terrace for example, offering a feeling of space, comfort and security. It is the only system with automatic opening. By pressing down the movable part, it rises instantly and reaches its extended height to enclose a terrace for example, offering a feeling of space, comfort and security.

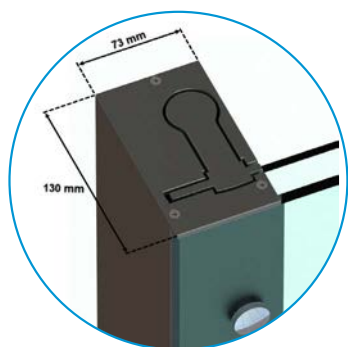
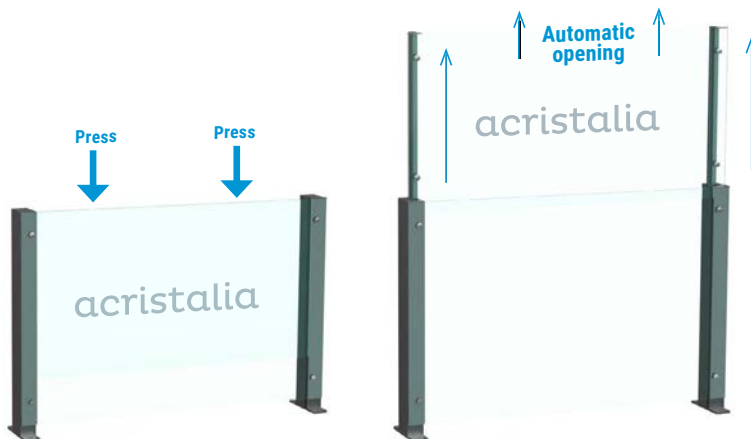

H = folded height
H + 700 mm = extended height
A = width



Floor-mounted base option

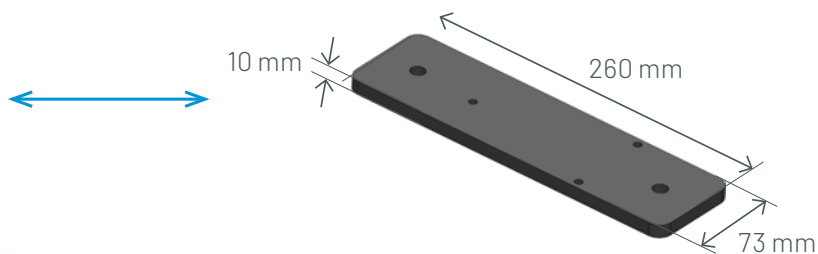

- Pair of posts (aluminium); 2 posts per unit (right + left).
- Anchorage plates 73 x 260 mm with 11 mm drills for fastening.
- Maximum width (per unit): 2000 mm.
- Made for tempered glass: 8 mm for the fixed part and 6 mm for the movable part.
- Delivered without glass.
- Standard finish: RAL 7016 MATT.
- Other finishes upon request.

Technical details

Details matter and make the difference. At Acristalia, we work constantly on developing new systems as we strive to excel when it comes to offer efficient solutions for the final customer's comfort.

Acristalia registration

It is the guarantee seal and the tracking system of the product once installed. The Acristalia registration is on all the products integrally manufactured by the brand and guarantees it is not an imitation or a lower-quality brand. Moreover, it allows to recover the fabrication data and features of the project, even after several years. Thus, the Acristalia registration allows to facilitate the After-Sales Service and offers to the distributor a fast and efficient service in the event of trouble with all the concrete features of the project realized.

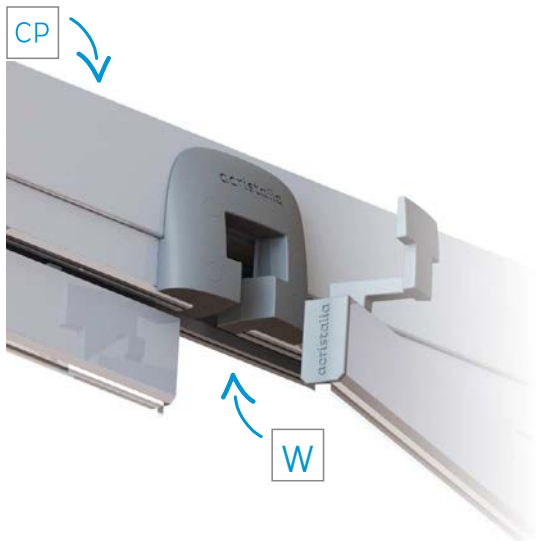

(CP) COMPENSATION PROFILE



(W) WHEEL OUTLET

1. The compensation profile (CP) corrects the potential differences of levels that could occur during the installation.
2. By eliminating the guide rod (arm) of the panels outlet (W), the glass curtains look more aesthetic and makes it easy to add accessories such as curtains or blinds.

The professionals' favourite products

Acristalia products require a proper installation since its quality and efficiency depend on it. The professionals of the sector opt for our enclosures as a sales tool as they offer a modern style and optimized system.



Flexibility

Our glass curtains offer all flexibility options. They can be adapted to every type of space: straight, with angles, polygonal shapes and others, making possible the installation for almost any project.

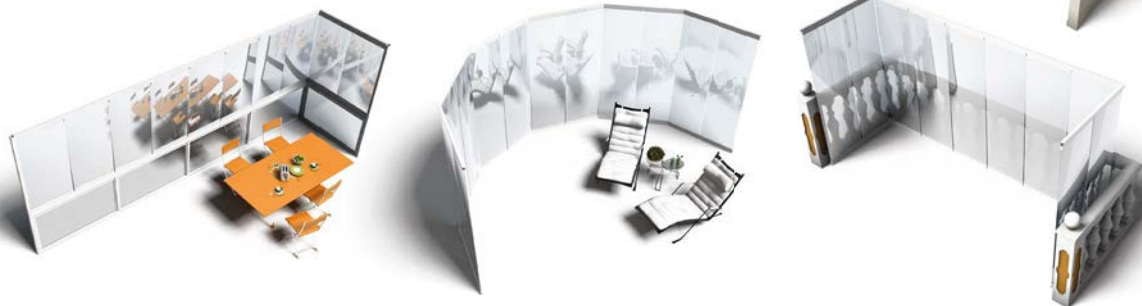

Sliding Series

Thanks to its design, the water slides along the surface, without water retention, to the drainage gutter.



Our sliding roof is designed to be installed from the inside.



Resistance tested in the most stringent laboratories

Certified by Tecnia to meet CTE requirements.

Side load →



Handles static linear loads up to 3 kN/m



LOCKING SYSTEMS

The locking system used for your glass curtains will depend on the security level you need and the opening direction of the panels. Let our sales representatives help you.

STANDARD LOCK



Stainless steel cable that connects the top and bottom latches when pulling it.

SLIDING LOCK

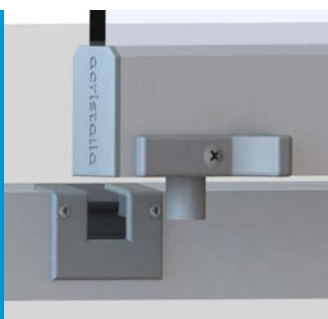

This solution offers a high resistance to winds and adverse weather conditions. It has been tested in laboratories, obtaining wind resistance up to 190 km/h.

DOOR KNOB



This system allows to activate the stainless steel cable to open the system with the opening latches. The knob can be installed inside, outside or both.

LOCK WITH HANDLE



It allows to close the main panel with a key, which offers the same level of protection as a security door. It can be installed on both sides of the door.

CLOSING SYSTEM WITH PANEL BLOCK



It blocks the lower part of the glass curtain with a key and lock. It allows to be protected from outside threats and is used as children safety lock.

One profile, three solutions.

Embedded solution

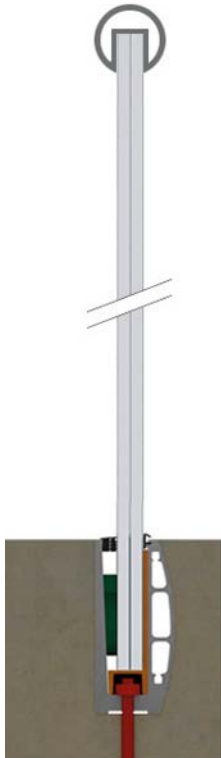

With the embedded solution, the profile is inserted by screwing it from the base with only the glass and the plastic seal remaining at sight.

Top-mounted solution

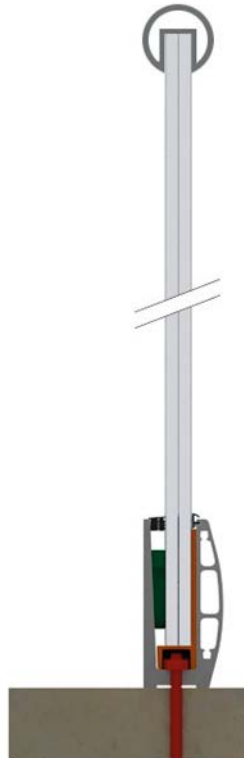

The top-mounted solution consists in screwing the profile to the ground, giving an extra protection to the glass.

Side-mounted solution

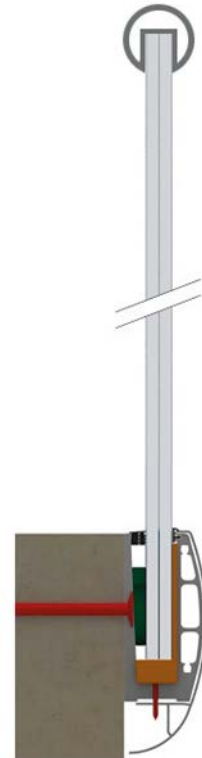

With the side-mounted solution, the profile is screwed to the slab from the outside and we add a covering profile.

Thanks to the compatibility of the Railing and Basic Pro Series, two products can be integrated in the same installation. A handrail will be added to connect the glass curtains to the railing. All the profiles are customizable and we offer a large range of supports, components and glass adjustment parts to provide you with the best solution.

Projects

Barceló Hotel Group

Cabo de Gata



Barceló Hotel Group

Sancti Petri



LEW HOAD



SES ROTES VELLES



LOS MARINOS



PROJET D'ARCHITECTURE
INTÉRIEURE, MAISON DU
XVIÈME SIÈCLE



RESTAURANT LE TXAMARA



LA FUSION & FLUNCH



HOTEL VILLA FLAMENCA



RESTAURANTE JOLASTOKI



HOTEL AGROTURISMO









— Authorized —
DISTRIBUTOR

**GIBCA FURNITURE
INDUSTRY CO.LTD.(L.L.C)**

Website: www.gfiuae.com

Address: P.O. Box 20923,
AJMAN – UAE

Tel.: +971 (0) 67436888

Fax: +971 (0) 67436903